

Shadowspec  
**UNITY**<sup>TM</sup>  
*Multi-Canopy Cantilever Umbrella*



## The Evolution of Shade



Fabric  
Warranty\*  
BEST-IN-CLASS



Frame  
Warranty\*  
BEST-IN-CLASS



Trusted for  
over 25 years



Hand-built in  
New Zealand



Marine  
Grade



# SHADOWSPEC UNITY™ Multi-Canopy Cantilever Umbrella

## Patented & Trademarked Technology



### SHADOWLIFT™

Gas-assisted deployment for an easy lift.



### SHADOWGLIDE™

Engineered to open or close in 5 seconds.



### SHADOWHUB™

LED light technology built-in and app controlled.

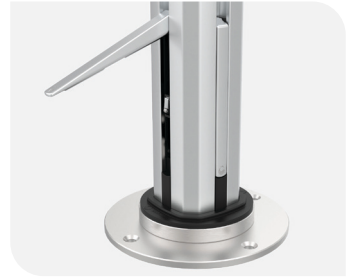

### SHADOWLOCK™

Integrated security and wind-protection.

## Canopy



### Quick-Ship Colors



Oyster

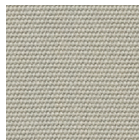

Alpine Stone



Charcoal Tweed

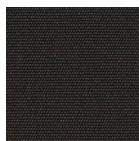

Black

### Special-Order Colors\*\*

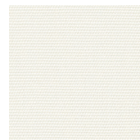

Natural



Storm



Charcoal



Slate

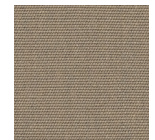

Taupe

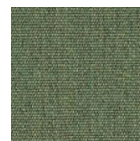

Fern

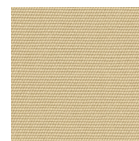

Linen



Sunflower Yellow

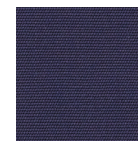

Captain Navy

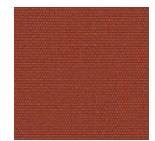

Terracotta

\*\*Special-Order Colors are non-stock and will incur an additional lead time and surcharge. Full Sunbrella Marine Range or other identical fabrics are available as a custom color option.



RECASENS  
BCN 1886

### Solution Dyed Acrylic

Some fabric dyeing methods only coat the outer surface of the fiber – think of a radish.

With the Solution Dyed method, each individual thread fiber is dyed – think of a beetroot. The fabric is also easy to clean and covered by a 10 year warranty.

### Frame Color



Space Grey



Heron Black\*\*\*

\*\*\*Available in 10' Square or 13' Octagon sizes only.



Marine Grade



Solution-dyed, High Color Fastness



UV and Fade Resistant



UPF 80 UV Protection



Eco-friendly Production



Breathable Weave



Mold and Mildew Resistant



Oil and Stain Repellent



Easy Clean



Water Resistant



Chlorine Resistant



Tear Resistant

## Size & Configuration

### OCTAGON UNO

11' | 3.5m or 13' | 4.0m

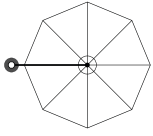

### OCTAGON DUO

22' | 7.0m or 26' | 8.0m

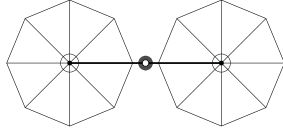

### SQUARE UNO

8' | 2.5m or 10' | 3.0m

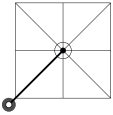

### SQUARE DUO

16' | 5.0m or 20' | 6.0m

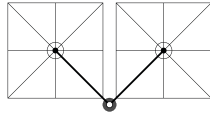

### SQUARE DUO

16' | 5.0m or 20' | 6.0m

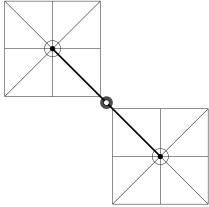

### SQUARE TRIO

16' | 5.0m or 20' | 6.0m

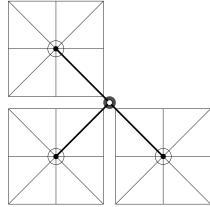

### SQUARE QUATTRO

16' | 5.0m or 20' | 6.0m

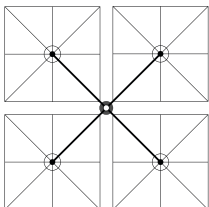

*All sizings and conversions are approximate and subject to change without notice. Refer to specsheets for exact, up-to-date measurements.*

## Features



### EASY OPEN & CLOSE

Umbrella deployment system with no winding or cables.



### MARINE GRADE

No-rust, 316 Stainless Steel Spigot.

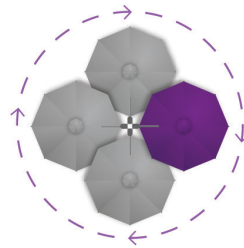

### FOLLOW THE SUN

Enjoy the 360° rotation for all-day-shade.



**10 YEAR**  
Fabric Warranty\*



**6 YEAR**  
Frame Warranty\*

### BEST-IN-CLASS WARRANTY

## Accessories

*N.b. Accessories are optional. Pricing additional.*



### RAIN GUTTER

Connects adjoining canopies to enhance rain protection.



### LED LIGHT CONTROL

Power your light with the Smart Battery or Hardwire Kit.



### PROTECTION COVER

Recommended protection for your umbrella when not in use.



### CASTOR WHEELS FOR FREE-STANDING BASE

## Mounting Options

### SURFACE PLATE

For deck, patio and concrete mounting. (316 stainless steel)



### IN-GROUND ANCHOR

For mounting with a concrete footing.



### WALL MOUNT BRACKET

For when ground mounting isn't possible. (316 stainless steel)



### FREE-STANDING BASE + ALUMINUM BASE COVER

For complete customized manoeuvrability.



*Note: Fastenings are not supplied for the Surface Plate or Wall Mount Bracket.*

*Available in Space Grey or Heron Black. Concrete pavers (not included) are required for ballast. Optional Castor Wheels available.*

# Dimensions

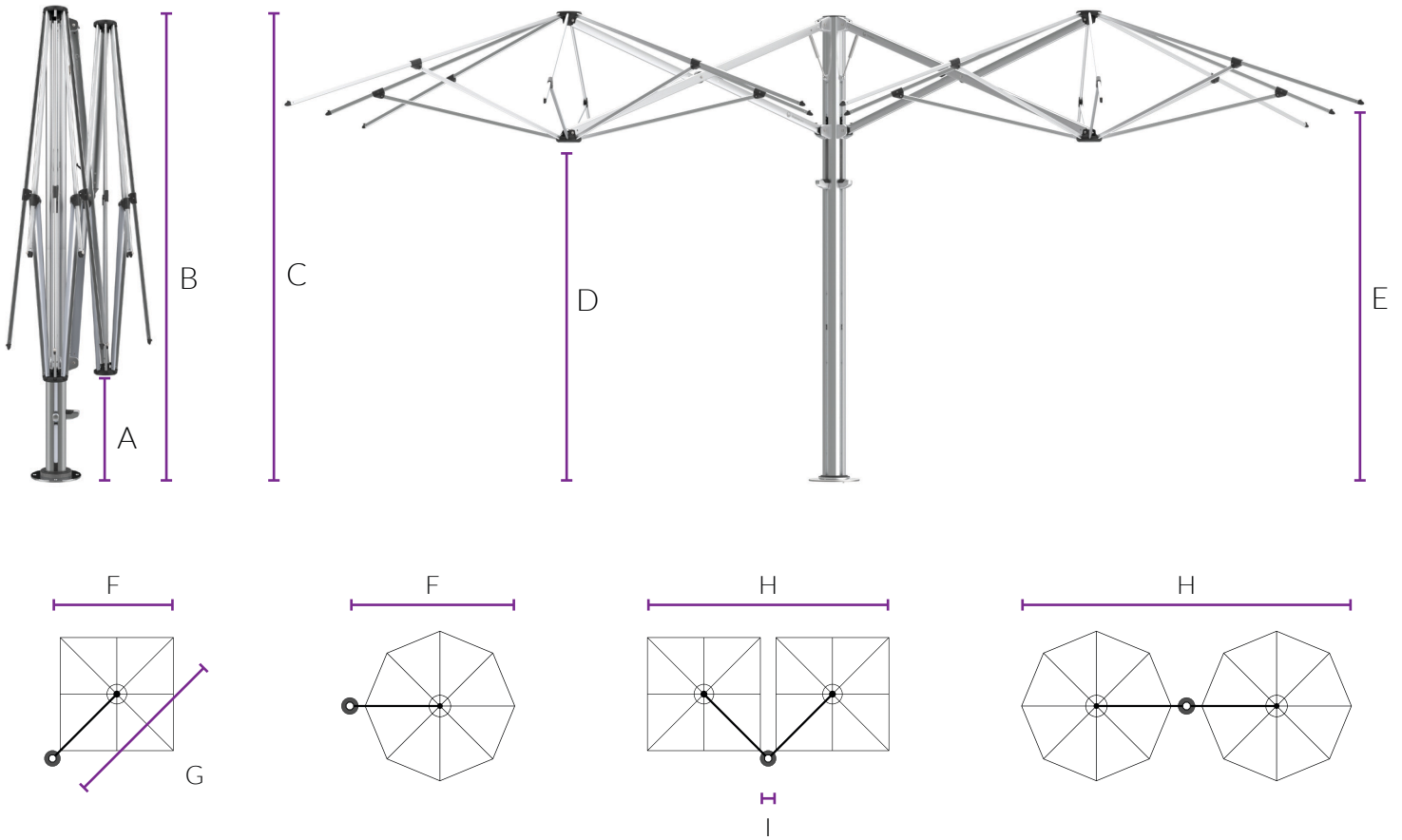

## Diagram Legend

	8'	2.5m	10'	3.0m	11'	3.5m	13'	4.0m
<b>A</b>	2'10"	860mm	2'1"	620mm	3'7"	1079mm	2'10"	866mm
<b>B</b>	9'6"	2900mm	9'3"	2824mm	9'9"	2975mm	9'6"	2899mm
<b>C</b>	9'6"	2908mm	9'6"	2908mm	9'7"	2908mm	9'6"	2908mm
<b>D</b>	7'0"	2130mm	6'9"	2054mm	7'3"	2205mm	7'0"	2128mm
<b>E</b>	7'3"	2222mm	7'3"	2219mm	7'4"	2237mm	7'2"	2172mm
<b>F</b>	8'8"	2646mm	9'10"	2973mm	11'4"	3447mm	12'10"	3923mm
<b>G</b>	12'3"	3742mm	13'10"	4205mm	N/A	N/A	N/A	N/A
<b>H</b>	17'4"	5292mm	19'6"	5946mm	22'7"	6894mm	25'9"	7846mm
<b>I</b>	6"	160mm	6"	160mm	N/A	N/A	N/A	N/A

\*Free-Standing Base installations will add 6" | 165mm to the height and surface plates will add 1/2" | 12mm to the height. Adding the optional Castor Wheels to the Free-standing Base will increase height a further 2-3" | 45-80mm to the height. All sizings and conversions are approximate and subject to change without notice. Refer to specsheets for exact, up-to-date measurements.



**shadowspec**  
umbrellas with distinction